

HURRICANE POWER

Commercial Debris Blower Operator's Manual

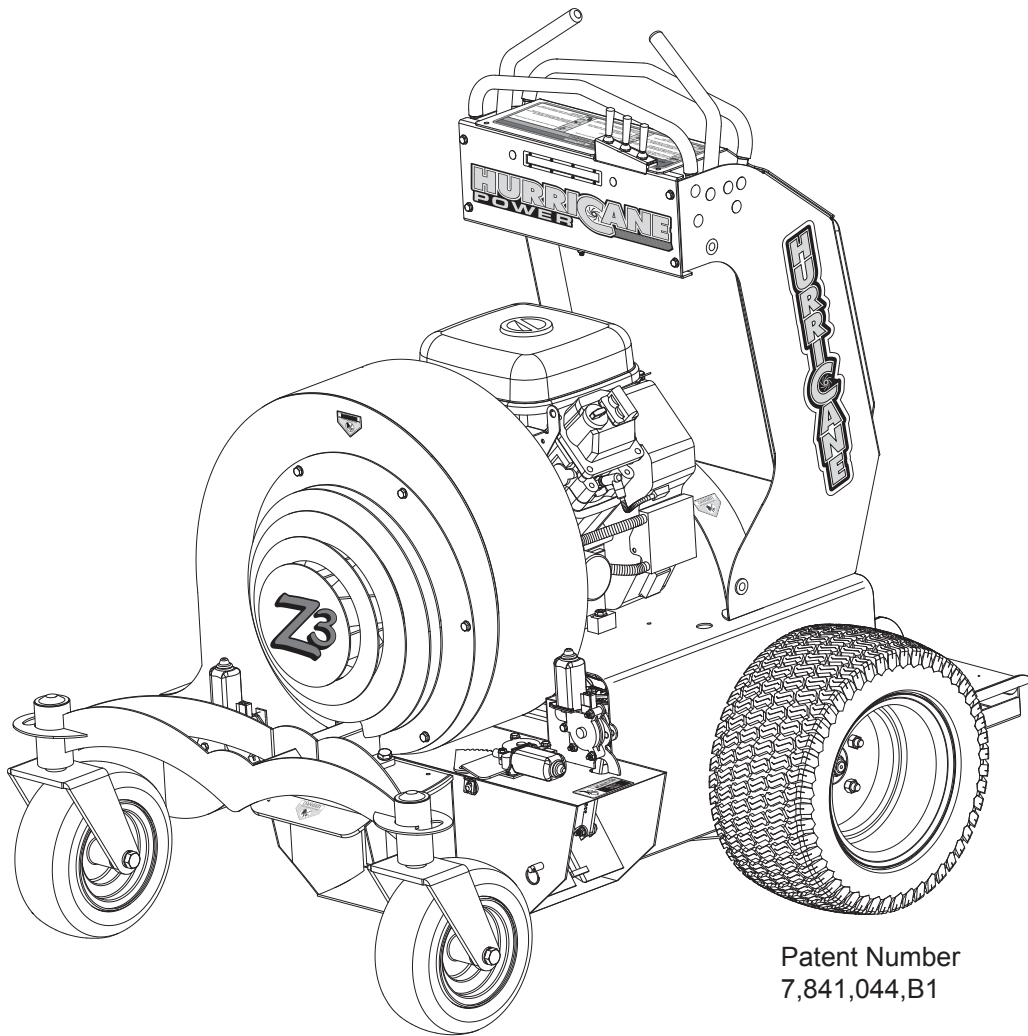

Patent Number
7,841,044,B1

Hurricane Inc.
Muskegon, Michigan

TABLE OF CONTENTS

IDENTIFICATION	1
Record Identification Numbers.....	1
INTRODUCTION	2
Using Your Operator's Manual.....	2
Special Messages	2
SPECIFICATIONS	3
SAFETY	4
Operator Training Required	4
Preparation.....	4
Operating Safely	4
Using a Spark Arrestor	5
Checking Working Area.....	5
Parking Safely	5
Rotating Impeller is Dangerous	6
Protect Children.....	6
Avoid Tipping	6
Keep Riders Off.....	7
Avoid High Pressure Fluids	7
Checking Wheel Hardware.....	7
Wear Appropriate Clothing	7
Maintenance and Storage	7
Prevent Fires	8
Tire Safety.....	8
Handling Fuel Safely.....	8
Handling Waste Product and Chemicals.....	9
DECALS	10
OPERATING	11
Operator Station Controls.....	11
<i>Parking Brake</i>	11
Operator Station Controls.....	12
Misc. Controls and Checks	13
Testing the Safety Systems	15
Testing the Parking Brake	15
Using the Throttle and Choke	16
<i>Starting Using the Throttle and Choke</i>	16
Filling Fuel Tank.....	16
Transaxle Bypass Valve	17
Using the Hydrostatic Motion Controls.....	18
Using the Blower and the Deflector Controls	19
Dual Deflector System (Left Deflector).....	19

SERVICE	21
Service Intervals	21
Service Engine	21
Checking Engine Oil Level	22
Changing Engine Oil and Filter	23
Cleaning Engine Oil Cooler and Checking Air Filter	23
<i>Cleaning the Engine Oil Cooler</i>	23
Checking Air Filter Elements	24
Replacing Fuel Filter	24
Checking Engine Cooling Intake and Fan	25
Checking Spark Plugs	25
Checking Carburetor Adjustment	25
Service Hydraulics	25
Checking Hydraulic Oil Level	25
Changing Hydraulic Oil and Filters	26
<i>Purging Procedure</i>	27
Impeller Removal and Inspection	28
Changing Drive Belt	28
Service Brakes	29
Service Motion Controls	30
<i>Adjusting the Motion Controls</i>	30
<i>Adjusting Motion Controls - Checking Neutral Center</i>	30
<i>Adjusting Motion Controls Neutral Center</i>	30
Service Tires	32
<i>Removing and Installing Rear Drive Wheels</i>	32
<i>Removing and Installing Front Caster Wheels</i>	32
<i>Checking Tire Pressure</i>	32
Service Electrical	33
<i>Replacing Fuse</i>	33
<i>Removing and Installing Battery</i>	33
<i>Cleaning Battery and Terminals</i>	34
<i>Using Booster Battery or Jump Starting</i>	34
TROUBLESHOOTING	35
Using the Troubleshooting Chart	35
STORAGE	38
Storing Machine Safety	38
Preparing Machine for Storage	38
Preparing Fuel and Engine For Storage	38
Removing Machine From Storage	39

IDENTIFICATION

Record Identification Numbers

If you need to contact an Authorized Service Center for information on servicing, always provide the product model and serial numbers.

You will need to locate the model and serial numbers for the machine and for the engine of your machine and record the information in the spaces provided.

Date of purchase: _____

Dealer name: _____

Dealer phone: _____

PRODUCT IDENTIFICATION NUMBER:

Model Number: _____

Serial Number: _____

ENGINE MODEL, SPECIFICATION, AND SERIAL NUMBER:

Model Number: _____

Specification: _____

Serial Number: _____

Register this information with Hurricane Inc. by email at **info@hurricane-power.com**, be sure to include your contact information as well as the above data for warranty and service bulletins.



Above information can be found on this data plate and the engine data plate.

INTRODUCTION

Using Your Operator's Manual

This manual is an important part of your machine and should remain with the machine when you sell it.

Use the safety and operating information in the machine Operator's Manual to operate and service the machine safely and correctly.

This operator's manual explains the features and promotes the safe use of this machine. Please read it in its entirety and follow the instructions carefully so that you may have many years of safe and productive operation.

An engine manufacturer's owner's manual has been provided with your machine. This will provide maintenance and troubleshooting information for the engine installed in your machine.

Special Messages

Your manual contains special messages to bring attention to potential safety concerns, machine damage as well as helpful operating and servicing information. Please read all the information carefully to avoid injury and machine damage.

This is the safety alert symbol (). It is used throughout this manual and on the blower's safety decals to alert you to potential personal injury hazards. Obey all safety messages that follow this symbol to avoid possible injury or death. Read these instructions carefully. It is essential that you read the instructions and safety precautions before you attempt to work on or use this machine.

WARNING

This symbol with the "WARNING" indicates a potentially hazardous situation which, if not avoided, could result in death or serious injury.

CAUTION

This symbol with the word "CAUTION" indicates a potentially hazardous situation which, if not avoided, may result in minor or moderate injury.

SPECIFICATIONS

Engine	35hp
Refer to engine manufacturer's owner's manual for engine specifications.	
Drivetrain	
Type	Dual Hydrostatic
Transaxles	Hydraulic Independent Zero Turn (IZT)
Number of Speeds	Infinitely Variable
Electrical System	
Charging System	20 Amp
Ignition	Flywheel magneto
Starter	Solenoid Shift
Fuse	30 Amp Blade
Fuel System	
Fuel Type	Regular Unleaded Gasoline
Fuel Tank Location	Between uprights
Fuel Capacity	10.0 gallons
Steering and Brakes	
Steering	Dual Hydraulic Control Levers
Park Brake	Mechanical Lockout
Tires	
Rear	22 x 11.00 - 10
Front	13 x 5.50 - 6
Inflation Rear (Maximum)	22 psi
Inflation Front (Maximum)	28 psi
Battery	
Voltage	12-volt
BCI Group Size	8U1L
Capacities	
Fuel Tank	10.0 gallons
Hydraulic Oil (With Filter)	Approx. 5 quarts.
Hydraulic Filter	50 Micron
Engine Oil (With Filter)	2.5 quarts.
Dimensions	
Width	45"
Height	56"
Length	65"
Weight	895 lbs.

SAFETY

Operator Training Required

- Read the Operator's Manual and other training material. If the operator or mechanic cannot read English, it is the owner's responsibility to explain this material to them. This publication is available in other languages.
- Become familiar with the safe operation of the equipment, operator controls, and safety signs.
- All operators and mechanics should be trained. The owner of the machine is responsible for training the users.
- Never let children or untrained people operate or service the equipment. Local regulations may restrict the age of the operator.
- The owner/user can prevent and is responsible for accidents or injuries occurring to themselves, other people, or property.
- Train operators on the machine in an open, unobstructed area under the direction of an experienced operator.

Preparation

- Evaluate the terrain to determine what accessories and attachments are needed to properly and safely perform the job. Only use accessories and attachments approved by the manufacturer.
- Wear appropriate clothing including hard hat, safety glasses and hearing protection. Tie back long hair, remove loose clothing or jewelry that may get tangled in moving parts.
- Inspect the area where the equipment is to be used and remove all objects such as rocks, toys, etc. which can be thrown by the machine.
- Use extra care when handling gasoline and other fuels. They are flammable and vapors are explosive.
- Allow engine to cool down before fueling.
 - a. Use only an approved container.
 - b. Never remove gas cap or add fuel when engine is running. Do not smoke.
 - c. Never refuel or drain the machine indoors.

- Check that the operator's presence controls, safety switches and shields are attached and functioning properly. **DO NOT** operate unless they are functioning properly.

Operating Safely

- **NEVER** run an engine in an enclosed area where dangerous carbon monoxide fumes can collect.
- Only operate in good light, keeping away from holes and hidden hazards.
- Be sure all drives are in NEUTRAL and parking brake is ENGAGED before starting engine. Only start engine from the operator's position.
- Slow down and use extra care on hillsides. Be sure to travel in the recommended direction on hillsides. For this machine, drive **across** hillsides, **not up and down**. Turf conditions can affect the machine's stability. Use caution while operating near drop-offs. **DO NOT** operate machine within 5 feet of an embankment or drop-off.
- Slow down and use caution when making turns and when changing directions on slopes.
- **NEVER** operate with the shields, or other guards, not securely in place. Be sure all interlocks are attached, adjusted properly, and functioning properly.
- Do not change the engine governor setting or overspeed the engine. Operating the engine at excessive speed can increase the hazard of personal injury and machine damage.
- Stop on level ground, engage parking brake, close deflectors, and shut off engine before leaving the operator's position for any reason.
- Stop equipment and inspect impeller if an abnormal vibration occurs. Make necessary repairs before resuming operations.
- Keep hands and feet away from the intake and discharge.
- Look behind and down before backing up to be sure of a clear path.
- Never carry passengers. Keep pets and bystanders away.

- Slow down and use caution when making turns and crossing roads and sidewalks. Close deflectors if not blowing. Watch for traffic when operating near or crossing roadways.
- Be aware of the blower discharge direction and **DO NOT** point it at anyone.
- **DO NOT** operate the machine while under the influence of alcohol or drugs.
- Use care when loading or unloading the machine into or off of a trailer or truck.
- Use care when approaching blind corners, shrubs, trees, or other objects that may obscure vision.
- Inspect machine before you operate. Be sure hardware is tightened securely. Repair or replace damaged, badly worn, or missing parts. Be sure guards and shields are in good condition and fastened in place. Make any necessary adjustments before you operate.
- Before using, **always visually inspect** to see that the impeller, its bolt, and blower assembly are not worn or damaged. Replace worn or damaged impeller and bolt.
- Keep safety decals visible when installing accessories and attachments.
- Do not wear radio or music headphones. Safe service and operation require your full attention.
- When machine is left unattended, stored, or parked, remove the key.

Using a Spark Arrestor

The engine in this machine is equipped with a spark arrestor muffler. It is a violation of California Public Resource Code Section 4442 to use or operate this engine on or near any forest-covered, brush-covered or grass-covered land unless the exhaust system is equipped with a spark arrestor meeting any applicable local or state laws. Other states or federal areas may have similar laws.

An installed spark arrestor must be maintained in good working order by the operator.

Checking Working Area

- Evaluate the terrain to determine what accessories and attachments are needed to properly and safely perform the job.
- **Clear work area** of objects that might be thrown. Keep people and pets out of working area.
- Study working area. Set up a safe blowing pattern. Do not blow where traction or stability is doubtful.
- Test drive through area with blower not running. Slow down when you travel over rough ground.

Parking Safely

1. Stop machine on a level surface, not on a slope.
2. Close deflectors.
3. Engage the parking brake.
4. Stop the engine.
5. Remove the key.
6. Wait for engine and all moving parts to stop before you leave the operator's station.
7. Close fuel shut-off valve, if your machine is equipped.
8. Disconnect the negative battery cable or remove the spark plug wires (for gasoline engines) before servicing the machine.

Rotating Impeller is Dangerous



Rotating impeller can cut off arms and legs, and throw objects. Failure to observe safety instructions could result in serious injury or death.

- **Keep hands, feet and clothing away** from blower housing when engine is running.
- Be alert at all times, drive forward carefully. People, especially children can move quickly into the working area before you know it.

Protect Children

- Death or serious injury can occur when young children associate having fun with a lawn equipment simply because someone has given them a ride on a machine.
- Children are attracted to lawn equipment and activities. They don't understand the dangers or the fact that the operator is unaware of their presence.
- Children who have been given rides in the past may suddenly appear in the work area for another ride and be run over or backed over by the machine.
- Tragic accidents with children can occur if the operator is not alert to the presence of children, especially when a child approaches a machine from behind. **Before and while backing up, look down and behind** the machine carefully, especially for children.
- **NEVER** carry children on a machine or attachment. Do not tow children in a cart or trailer. They can fall off and be seriously injured or interfere with safe machine operation.
- Never use the machine as a recreational vehicle or to entertain children.
- Never allow children or an untrained person to operate the machine. Instruct all operators not to give children a ride on the machine or in an attachment.

- Keep children indoors, out of the work area, and in the watchful eye of a responsible adult, other than the operator, when a machine is being operated.
- Stay alert to the presence of children. Never assume that children will remain where you last saw them. Turn the machine OFF if a child enters the work area.

Avoid Tipping

- Slopes are a major factor related to loss-of-control and tip-over accidents, which can result in severe injury or death. **Operation on all slopes requires extra caution.**
- Blow across slopes, not up and down.
- Watch for holes, ruts, bumps, rocks, or other hidden objects. Uneven terrain could overturn the machine. Tall grass can hide obstacles.
- Choose a low ground speed so you will not have to stop while on a slope.
- Do not blow or operate machine on wet grass. Tires may lose traction.
- Tires may lose traction on slopes even though the brakes are functioning properly.
- Avoid starting, stopping or turning on a slope. If the tires lose traction, turn and proceed slowly, straight down the slope.
- Keep all movement on slopes slow and gradual. Do not make sudden changes in speed or direction, which could cause the machine to roll over.
- Use extra care while operating machine with attachments, they can affect stability of the machine. **Do not use on steep slopes.**
- Do not blow near drop-offs, ditches, embankments, or bodies of water. The machine could suddenly roll over if a wheel goes over the edge or the edge caves in.
- Follow the manufacturer's recommendations for wheel weights or counterweights for added stability when operating on slopes or using front or rear mounted attachments. Remove weights when not required.
- Drive machine very slowly and avoid quick stops.

Keep Riders Off

- Only allow the operator on the machine. Keep riders off.
- Riders on the machine or attachment may be struck by foreign objects or thrown off the machine causing serious injury.
- Riders obstruct the operator's view resulting in the machine being operated in an unsafe manner.

Avoid High Pressure Fluids

- Hydraulic hoses and lines can fail due to physical damage, kinks, age, and exposure. Check hoses and lines regularly. Replace damaged hoses and lines.
- Hydraulic fluid connections can loosen due to physical damage and vibration. **Check connections regularly.** Tighten loose connections.
- Escaping fluid under pressure can penetrate the skin causing serious injury. Avoid the hazard by relieving pressure before disconnecting hydraulic or other lines. Tighten all connections before applying pressure.
- Search for leaks with a piece of cardboard. Protect hands and body from high pressure fluids.
- If an accident occurs, **see a doctor immediately.** Any fluid injected into the skin must be surgically removed within a few hours or gangrene may result. Doctors unfamiliar with this type of injury should reference a knowledgeable medical source.

Checking Wheel Hardware

- An accident could occur causing serious injury if wheel hardware is not fastened.
- Check wheel hardware tightness often during the first 100 hours of operation. Torque to 75 ft-lbs.
- Wheel hardware must be tightened to specified torque using the proper procedure anytime it is loosened.

Wear Appropriate Clothing

- Always wear safety goggles, or safety glasses with side shields, and a hard hat when operating the machine.
- Wear close fitting clothing and safety equipment appropriate for the job.
- While blowing, always wear substantial footwear and long trousers. **DO NOT** operate the equipment when barefoot or wearing open sandals.
- Wear a suitable hearing protection device such as earplugs. Loud noise can cause impairment or loss of hearing.

Maintenance and Storage

- **NEVER** operate machine in a closed area where dangerous carbon monoxide fumes can collect.
- Disengage drives, engage parking brake, stop engine and remove key or disconnect spark plug (for gas engines). Wait for all movement to stop before adjusting, cleaning or repairing.
- Clean all debris from machine, drives, mufflers, and engine to help prevent fires. Clean up oil or fuel spillage.
- Let engine cool before storing and do not store near flame.
- Shut off fuel while storing or transporting. Do not store fuel near flames or drain indoors.
- Park machine on level ground. Never allow untrained personnel to service machine. Understand service procedure before doing work.
- Use jack stands or lock service latches to support components when required. Securely support any machine elements that must be raised for service work.
- Before servicing machine or attachment, carefully release pressure from any components with stored energy, such as hydraulic components or springs.
- Release hydraulic pressure by moving hydraulic control levers back and forth with the engine OFF.

- Disconnect battery or remove spark plugs (for gas engines) before making any repairs. Disconnect the negative terminal first and the positive last. Reconnect positive first and negative last.
- Use care when checking impeller. Wear gloves, and use caution when servicing them. Only **REPLACE** impeller. **Never attempt to straighten or weld them.**
- Keep hands, feet, clothing, jewelry and long hair away from moving parts. If possible, do not make adjustments with the engine running.
- Charge battery in an open well ventilated area, away from spark and flames. Unplug charger before connecting or disconnecting from battery. Wear protective clothing and use insulated tools.
- Keep all parts in good working condition and all hardware tightened. Replace all worn or damaged decals.
- Keep all nuts and bolts tightened securely, especially impeller attachment bolts, to be sure the equipment is in safe working condition.
- **Check brake operation frequently.**

Prevent Fires

- Remove debris from engine compartment and muffler area, before and after operating machine, especially after blowing in dry conditions.
- **ALWAYS** shut off fuel when transporting or storing machine, the machine has a fuel shutoff.
- **DO NOT** store machine near an open flame or source of ignition, such as a water heater or furnace.
- Check fuel lines, tank, cap, and fittings frequently for cracks or leaks. Replace if necessary.

Tire Safety

Explosive separation of a tire and rim parts can cause serious injury or death:

- Do not attempt to mount a tire without the proper equipment and experience to perform the job.

- Always maintain the correct tire pressure. **DO NOT** inflate the tires above the recommended pressure. Never weld or heat a wheel and tire assembly. The heat can cause an increase in air pressure resulting in a tire explosion. Welding can structurally weaken or deform the wheel.
- When inflating tires, use a clip-on chuck and extension hose long enough to allow you to stand to one side and NOT in front of or over the tire assembly.
- Check tires for low pressure, cuts, bubbles, damaged rims or missing studs and nuts.

Handling Fuel Safely

To avoid personal injury or property damage, **use extreme care in handling fuel.** Fuel is extremely flammable and fuel vapors are explosive:

- Extinguish all cigarettes, cigars, pipes, and other sources of ignition.
- Use only an approved fuel container. Use only non-metal, portable fuel containers approved by the Underwriter's Laboratory (U.L.) or the American Society for Testing & Materials (ASTM). If using a funnel, make sure it is plastic and has no screen or filter.
- Never remove the fuel tank cap or add fuel with the engine running. Allow engine to cool before refueling.
- Never add fuel to or drain fuel from the machine indoors. Move machine outdoors and provide adequate ventilation.
- Clean up spilled fuel immediately. If fuel is spilled on clothing, change clothing immediately. If fuel is spilled near machine, do not attempt to start the engine but move the machine away from the area of spillage. Avoid creating any source of ignition until fuel vapors have dissipated.
- Never store the machine or fuel container where there is an open flame, spark, or pilot light such as on a water heater or other appliance.
- Prevent fire and explosion caused by static electric discharge. Static electric discharge can ignite fuel vapors in an ungrounded fuel container.

- Never fill containers inside a vehicle or on a truck or trailer bed with a plastic liner. Always place containers on the ground away from your vehicle before fueling.
- Remove fuel-powered equipment from the truck or trailer and refuel it on the ground. If this is not possible, then refuel such equipment with a portable container, rather than from a fuel dispenser nozzle.
- Keep the nozzle in contact with the rim of the fuel tank or container opening at all times until the fueling is complete. Do not use a nozzle lock open device.
- **Never overfill fuel tank.** Replace fuel tank cap and tighten securely.
- Replace all fuel container caps securely after use.
- For gasoline engines, do not use gas with methanol. Methanol is harmful to your health and to the environment.

Handling Waste Product and Chemicals

- Waste products, such as, used oil, fuel, coolant, brake fluid, and batteries, can harm the environment and people:
- **DO NOT** use beverage containers for waste fluids - someone may drink from them.
- Contact your local Recycling Center or authorized dealer to learn how to recycle or get rid of waste products.
- Safety Data Sheets (SDS) provides specific details on chemical products: physical and health hazards, safety procedures, and emergency response techniques. The seller of the chemical products used with your machine is responsible for providing the SDS for that product.

DECALS



Operator Station



Belt Guard

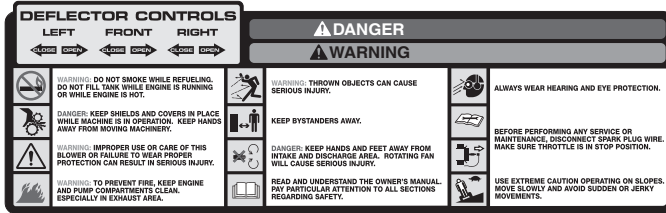

Left and Right Deflectors

Operator Station

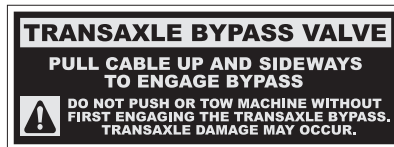

Bypass Valves

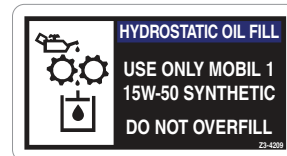

Hydrostatic Tank



Left and Right Uprights



Above Operator Platform



Top of Impeller Housing



Impeller Safety Cover

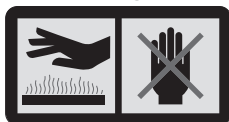

Impeller Housing

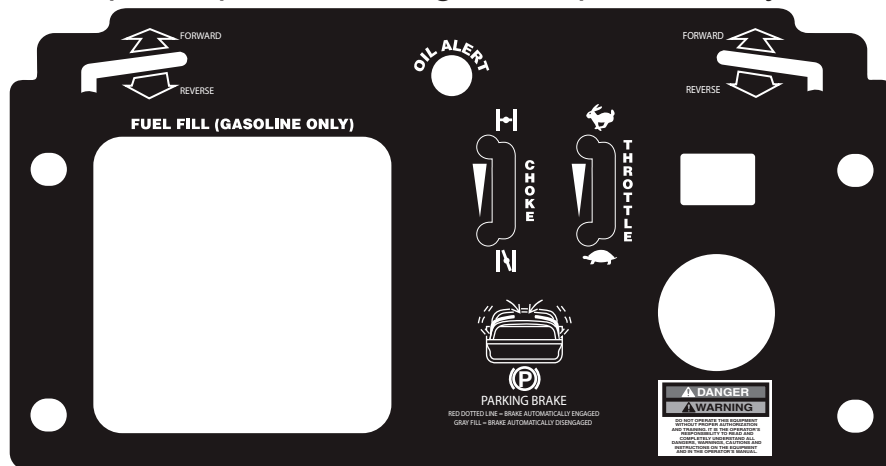

Operator Station

OPERATING

Operator Station Controls

- Please take a moment to become familiar with the controls on the dash. A clear understanding of the operation and function of each control is essential to the safe and productive use of this machine.

Parking Brake



Parking Brake Disengaged

- This photo shows the parking brake in the **DIS-ENGAGED** position.



Parking Brake Engaged

- This photo shows the parking brake in the **EN-GAGED** position with all other controls in the OFF/NEUTRAL position. The parking brake should be in this position starting, parking, or anytime other than when the machine is in motion with an operator present at the controls.

Operator Station Controls

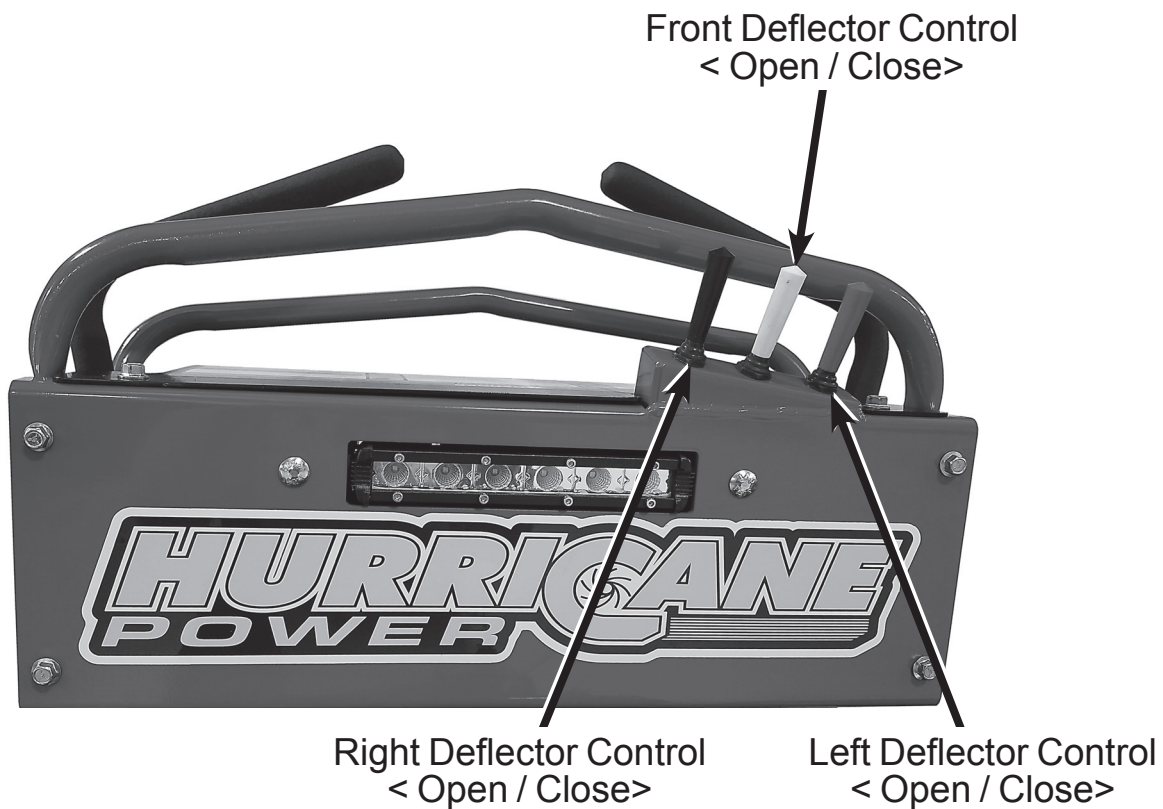
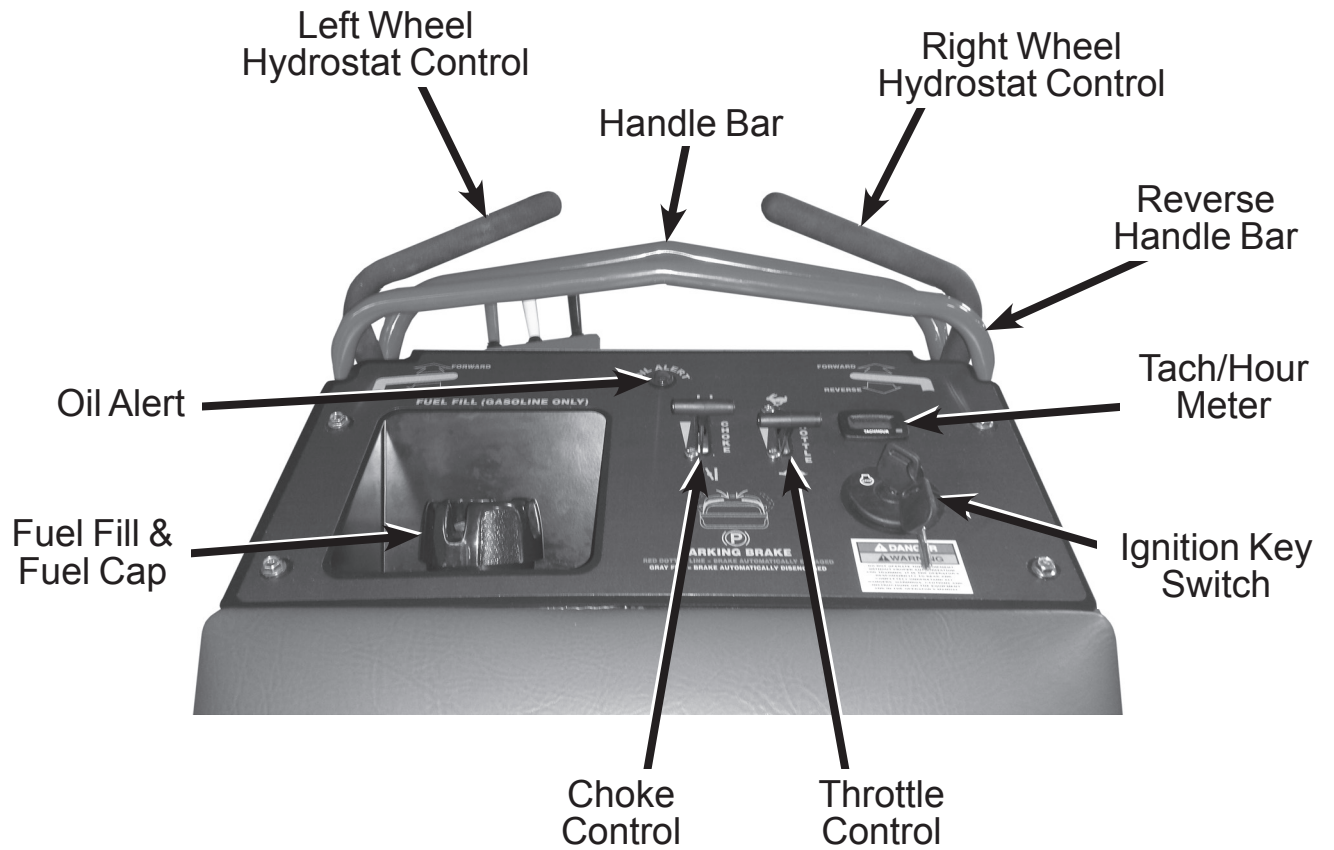

Misc. Controls and Checks

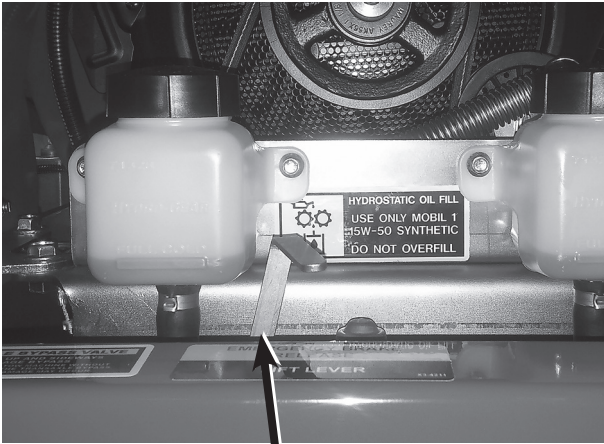

Emergency Brake Release Lever

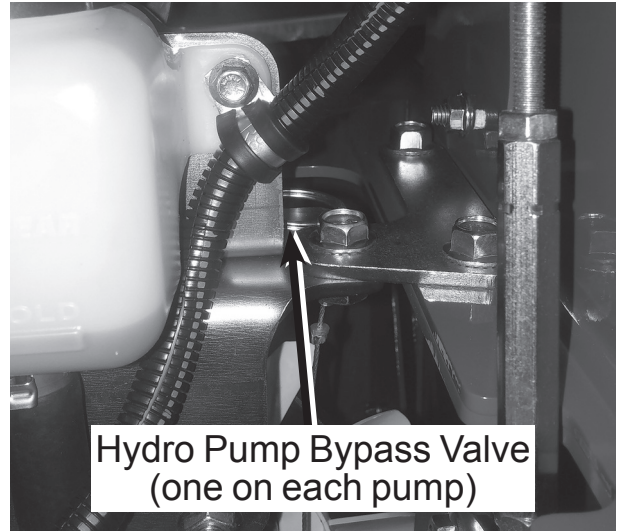

Hydro Pump Bypass Valve (one on each pump)

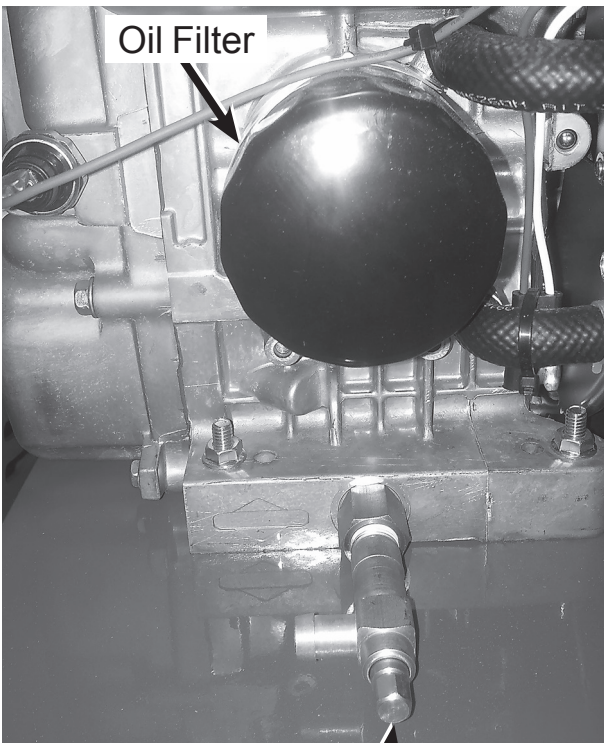

Oil Filter

Oil Drain Valve

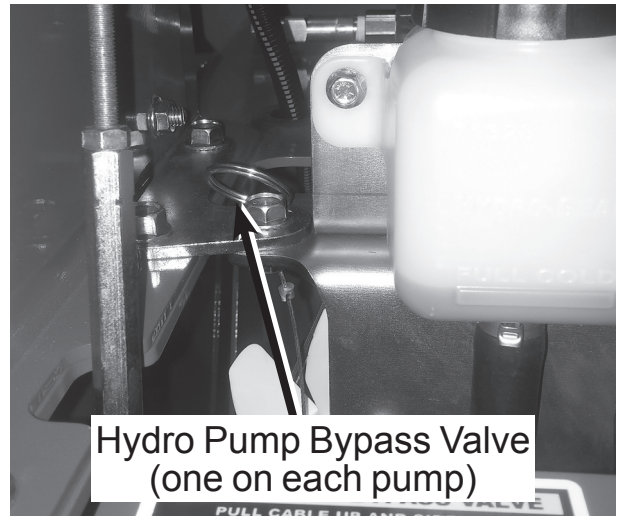

Hydro Pump Bypass Valve (one on each pump)

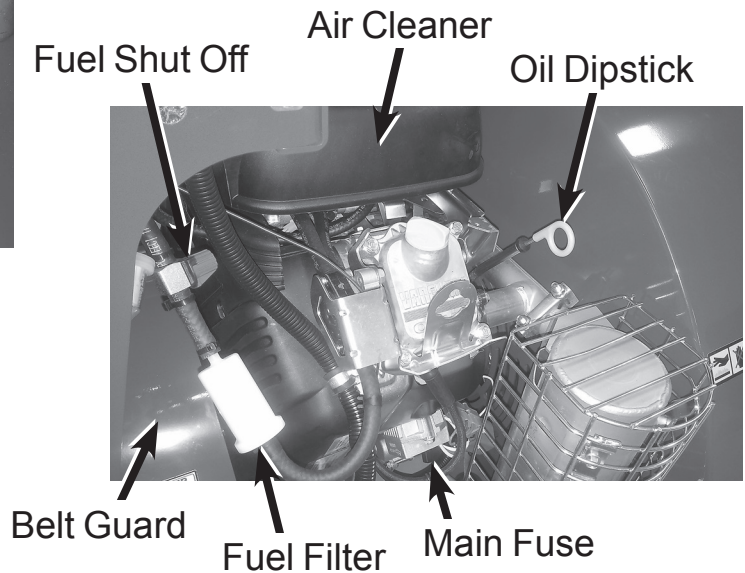

Fuel Shut Off

Air Cleaner

Oil Dipstick

Belt Guard

Fuel Filter

Main Fuse

Hydraulic Oil Filters
One on each pump.

Break-In Period:
First service at 75 hours
After that every 400 hours

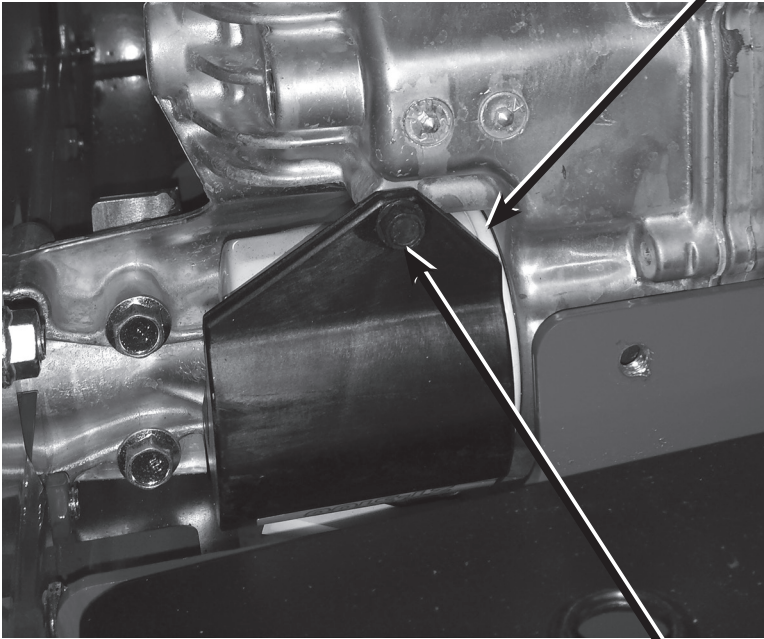

Hydraulic Pumps
Change hydraulic oil
every 400 hours.

Remove Filter Guard
bolts to access filter for
service.

Testing the Safety Systems

The safety systems installed on your machine should be tested before each machine use. Be sure you have read this manual and are completely familiar with the operation of the machine before performing these safety system checks.

If there is a malfunction during one of these procedures, do not operate machine. Contact your authorized dealer for service.

Perform these tests in a clear, open area outdoors. Keep bystanders away.

Use the following checkout procedures to check for normal operation of the machines safety systems.

Testing Park Brake Switch (Start)

1. Turn key to the ON position.
2. Push both handles down to disengage parking brake.
3. Turn key switch to the START position.

Result: The engine must not crank over.

Testing Neutral Switch (Start)

1. Push one motion control lever forward.
2. Turn key switch to the START position. Repeat steps 1, 2 for other control.

Result: The engine must not crank.

Testing Emergency Parking Brake Release

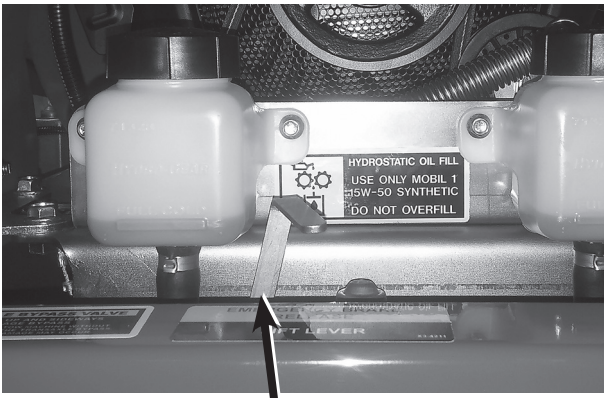

Emergency Brake Release Lever

1. Turn key to the ON position.
2. Lift emergency brake release lever you will hear the brake disengage and reset.
3. Turn key to the START position.

Result: The engine will turn over, this means all brake safety switches are working properly.

Testing the Parking Brake

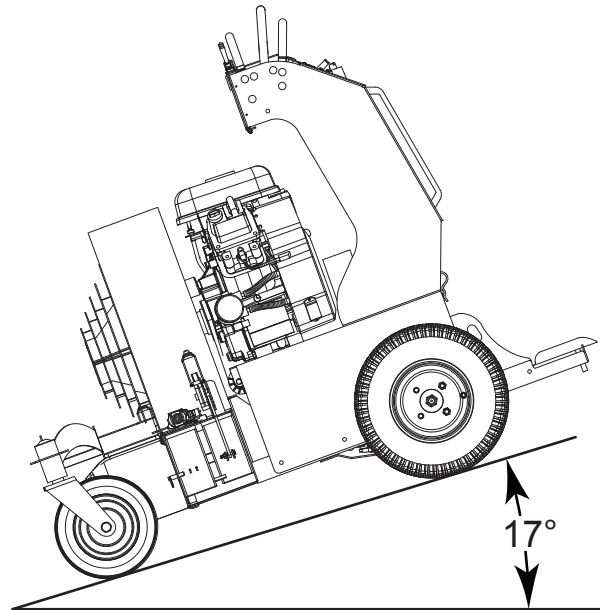

1. Stop machine on a 17° slope (30% grade) facing downhill. Stop the engine and engage parking brake.
2. Repeat procedure with machine facing uphill.

Result: Parking brake must hold the machine stationary. (Machine should move no more than 24 in. (61cm) in one hour.) If machine moves more than that, contact your authorized dealer.

Testing Automatic Parking Brake Set

1. Stand on operator's platform with motion control levers in the NEUTRAL parking brake position.
2. Start engine. Idle engine.
3. Disengage parking brake.
4. Move motion control levers slightly forward, slower than walking speed.
5. Release the motion control levers, allowing them to return to the NEUTRAL position and tip up.

Result: The engine is running and the parking brake is now set, unit will not roll.

Using the Throttle and Choke

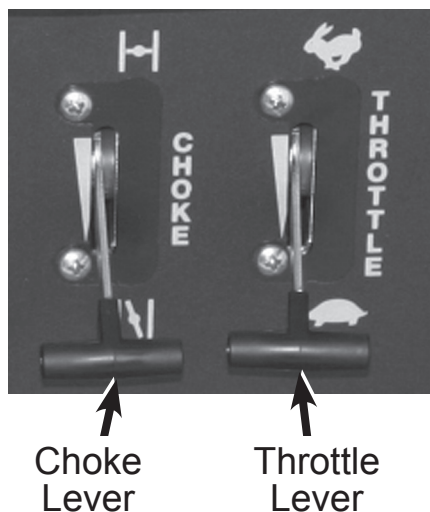

Starting Using the Throttle and Choke

- Push choke lever forward to the CLOSED position.
- Move throttle lever to the HALF FAST position when starting and warming the engine.
- Turn key switch to the START position and release when engine starts, pulling choke control back to the OPEN position after engine start.
- Blower speed and power can be controlled with the throttle control.



- The Tach/hour meter shows the engine revolutions per minute when the engine is running and the engine hours when engine is off. The meter will also show reminders when to change the engine oil. The meter only runs when the engine is running and is independent of the key switch.

Filling Fuel Tank

CAUTION

Avoid injury! Fuel vapors are explosive and flammable.

- Shut engine OFF before filling fuel tank.
- Do not smoke while handling fuel.
- Keep fuel away from flames or sparks.
- Fill fuel tank outdoors or in well ventilated area.
- Clean up spilled fuel immediately.
- Use clean approved non-metal container to prevent static electric discharge.
- Use clean approved plastic funnel without screen or filter to prevent static electric discharge.

IMPORTANT: Avoid damage! Dirt and water in fuel can cause engine damage:

- Clean dirt and debris from the fuel tank opening.
- Use clean, fresh, stabilized fuel.
- Fill the fuel tank at the end of each day's operation to keep condensation out of the fuel tank.
- Use a non-metallic funnel with a plastic mesh strainer when filling the fuel tank or container.



1. Park machine safely.
2. Allow engine to cool.
3. Remove any debris from around fuel tank cap.
4. Remove fuel tank cap slowly to allow any pressure built up in tank to escape.
5. Only fill fuel tank to bottom of filler neck. Do not overfill. Clean up spilled fuel immediately.
6. Re-install fuel tank cap.

Transaxle Bypass Valve

IMPORTANT: DO NOT push or tow machine without first engaging the transaxle bypass valve. Transaxle damage may occur.

To move the machine with the engine not running the transaxle bypass valve **must** be engaged.

1. Pull cable out past stop and move sideways to engage transaxle bypass valve.

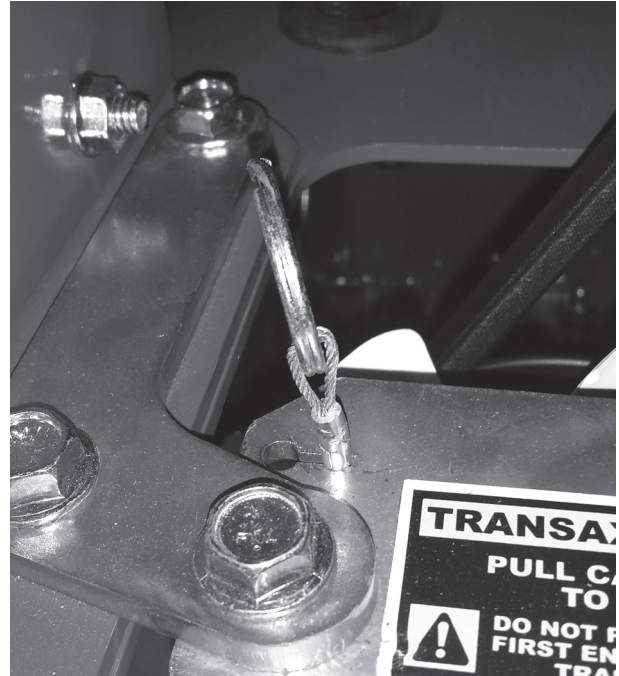

Transaxle Bypass Valve Engaged

2. After moving the machine, pull cable sideways allowing cable to retract and disengage transaxle bypass valve.

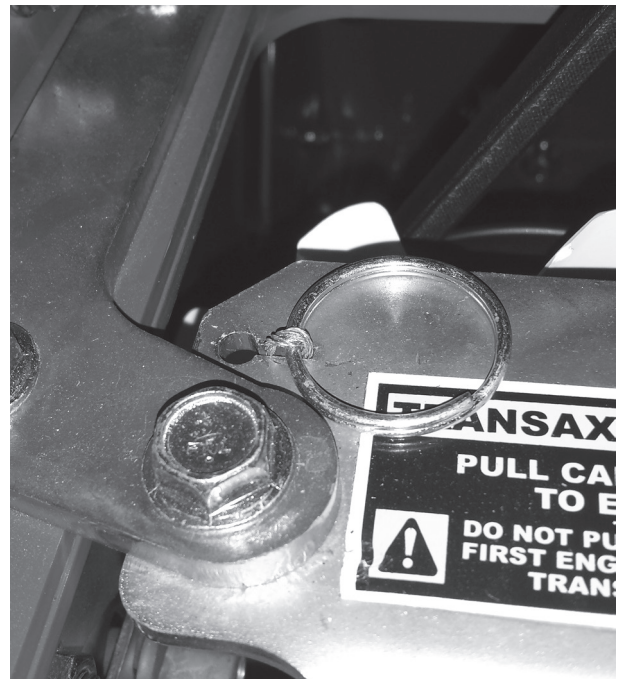

Transaxle Bypass Valve Disengaged

Using the Hydrostatic Motion Controls

⚠ CAUTION

Avoid injury! Learn the proper use of the motion control levers and practice at low throttle until becoming proficient and comfortable with the operation of the machine.

DO NOT move motion control levers from FORWARD to REVERSE or REVERSE to FORWARD position rapidly. Sudden direction changes could cause loss of control or damage the machine.

The functions of the hydrostatic motion control levers are:

- Forward and reverse movement.
- Steering.
- Acceleration and Deceleration.
- Stopping.



This photo shows the hydrostatic control levers are in the NEUTRAL position.



This is the NEUTRAL position.

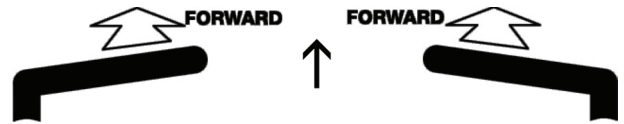

This is the FORWARD travel position. The travel speed is dependant on how far forward the controls are pushed.

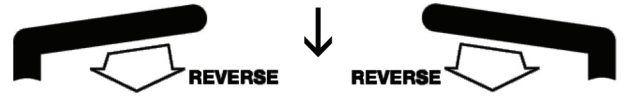

This is the REVERSE travel position. The travel speed is dependant on how far rearward the controls are pulled.

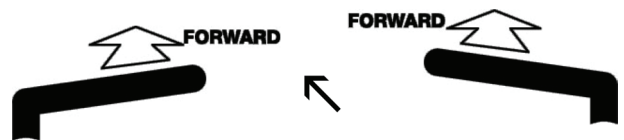

For a gentle left turn, Push the right motion control lever further forward than the left motion control lever.

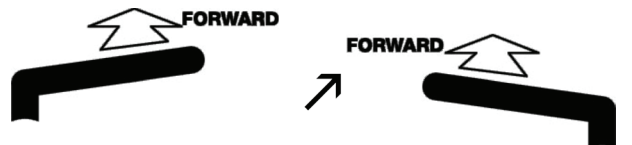

For a gentle right turn, Push the left motion control lever further forward than the right motion control lever.

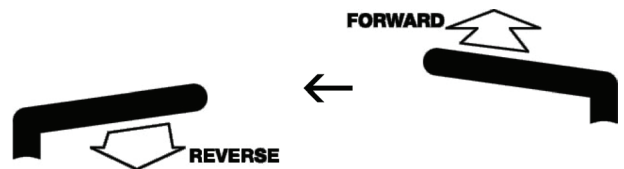

For a sharp left turn, Pull the left motion control lever rearward and push the right motion control lever forward.

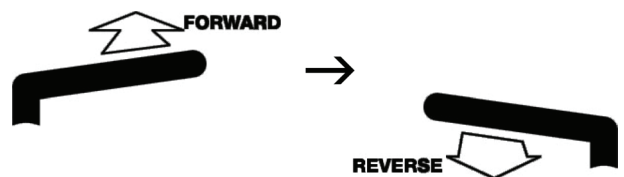

For a sharp right turn, Push the left motion control lever forward and pull the right motion control lever rearward.

Using the Blower and the Deflector Controls

CAUTION

Avoid injury and property damage! **DO NOT** position discharge where it will blow debris towards people, vehicles, buildings or other objects in vicinity. Flying debris may damage, harm, or cause injury to people or objects in air flow range. Keep a safe distance between two or more operators and machines when working together in the same areas.

**CAUTION**

Keep hands and feet away from air intake and air discharge. Pinch points and crushing forces will cause severe injury.

DANGER

Danger rotating fan - don't attempt to remove materials from intake or discharge when blower is running. Engage parking brake, stop engine, remove key and wait until all machinery has come to a complete stop.

The functions of the Deflector control switches are:

- Starting and Stopping the air stream.
- Adjusting the air pattern.



Deflector Control Switches

Dual Deflector System (Left Deflector)

The rear deflector is motor controlled. The front deflector is closed by the rear deflector. For normal blowing, run the front deflector at the halfway pin and adjust the rear deflector in the desired location.

This photo shows the deflectors in the CLOSED position.

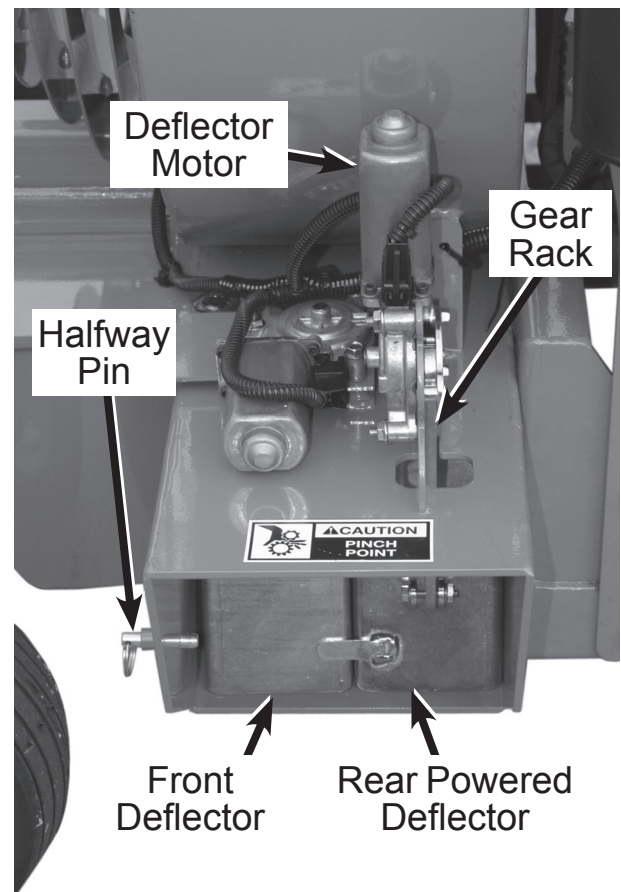

Deflector Closed

NOTE: The deflectors can be set in any position between OPEN and CLOSED.

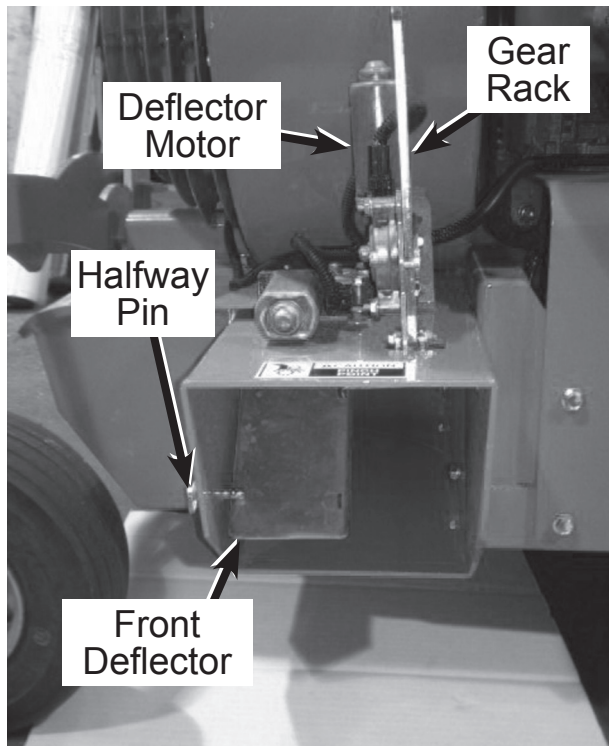

Deflector Open

With a little time and experience, an operator can become proficient in setting the deflectors at the optimum positions for the task.

HINT: From the operators position, the user can see the left deflector gear rack and judge the position of the deflectors.

With the deflectors at about half open, like the front deflector in the above photo, the air stream is directed downward under the debris and is useful for blowing wet leaves, grass and dirt.

For moving large piles of debris, remove the halfway pin allowing deflectors to open fully for maximum air flow.

REMEMBER: Air velocity can be controlled by the throttle control as well as by the deflectors.

REMEMBER: Air stream (deflectors) should be closed off when necessary (ie., when traveling from one area to another, past flower and bark beds, etc.).



Right Discharge Chute

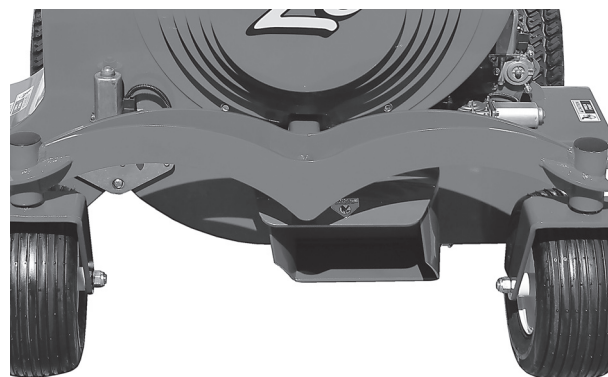

Front Discharge Chute

SERVICE**Service Intervals**

Use the following schedule to perform routine maintenance on your machine.

Service Item	Break-In (After First 10 Hours)	Every 40 Hours	First 75 Hours	Every 100 Hours	Every 400 Hours	Annually
Change engine oil and filter	x			x		
Check hydraulic fluid level	x	x				
Check parking brake	x	x				
Check wheel lug nut torque	x	x				
Check air pressure in tires	x	x				
Check hydraulic pump drive belt	x	x		x		
Check air cleaner elements		x				
Clean engine shrouds as needed		x				
Clean behind engine shrouds and exposed fins		x		x		
Clean behind engine cooling fan screen		x		x		
Change hydraulic oil and filters			x		x	
Clean and gap spark plugs				x		
Change fuel filter						x
Clean battery						x
Change engine oil and filter at least once per season						x
Change hydraulic oil and filters at least once per season						x
Replace spark plugs						x

Front Caster Wheels are grease-able and should be serviced monthly.

Service Engine

Servicing Engine

Refer to engine manufacturer's owner's manual provided with your machine for engine service information.

Engine Oil

Use oil viscosity based on the expected air temperature range during the period between oil changes. Refer to engine manufacturer's manual for the oil specifications.

Checking Engine Oil Level

IMPORTANT: Avoid Engine Damage! Failure to check the oil level daily could lead to serious engine problems if oil level is low.

Check oil level **before** operating.

Keep oil level between the FULL and the ADD marks.

Check oil level when engine is stopped, level, and is cooled so oil has had time to drain into the sump.

NOTE: Check oil **frequently** if you run engine all day.

Make sure engine is cool when checking engine oil level.

Check oil between jobs during periods of heavy use.

NOTE: Engine has an **OIL ALERT** light. If there is a loss of oil pressure or oil stop engine immediately. Check all oil levels. If warning light stays on for more than 30 seconds after start shut off engine and check oil.

1. Park machine safely.
 2. Check when engine is cool before use or allow engine to cool.
 3. Clean area around dipstick to prevent debris from falling into crankcase.
 4. Remove dipstick. Wipe with a clean cloth.
 5. Install dipstick fully.
 6. Remove dipstick and check oil level on dipstick. Oil must be between the ADD and FULL marks.
- If oil is low, add oil to bring oil level no higher than the FULL mark on dipstick.
 - If oil level is above the FULL mark, drain to proper level.

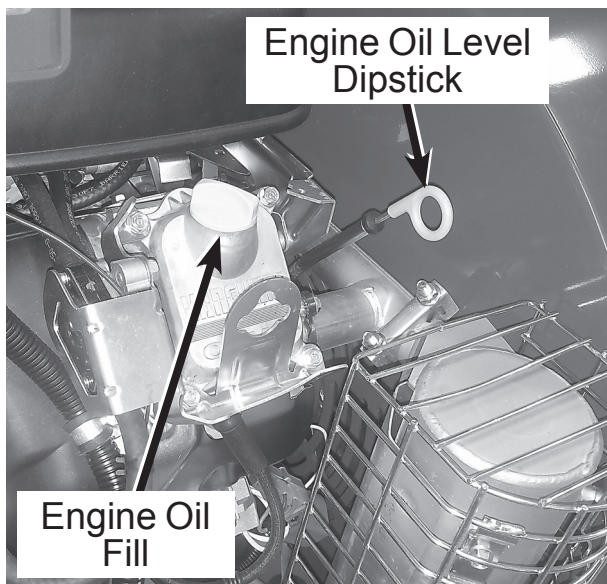

Changing Engine Oil and Filter

IMPORTANT: Avoid Damage! Change the oil more often if the machine is used in extreme conditions:

- Extremely dusty conditions.
 - Frequent slow or low-speed operation.
 - Frequent short trips.
1. Park machine safely.
 2. Clean area around dipstick, filler cap and filter.
 3. Make sure engine is cool.
 4. Put oil drain pan beside engine on drain valve side.

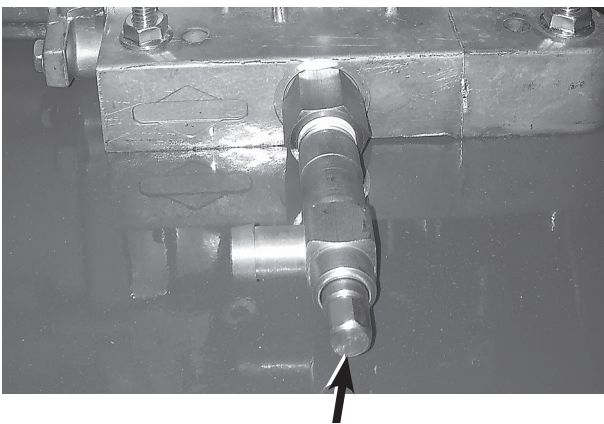

Oil Drain Valve

5. Place 18" of 1/2 ID hose on drain valve.
6. Open oil drain valve fully.
7. Allow oil to drain into an oil drain pan.
8. After oil drains, securely tighten oil drain valve.
9. Remove drain hose.

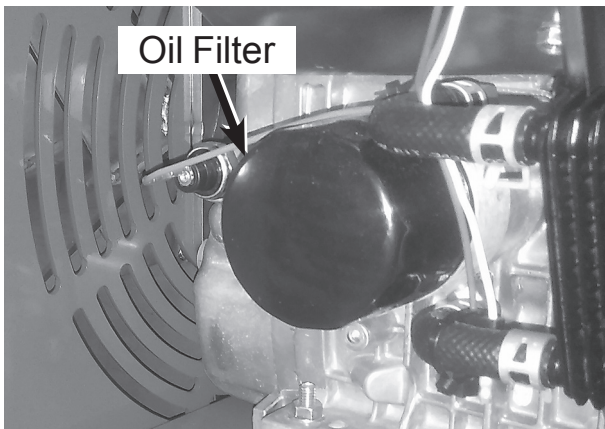

IMPORTANT: Make sure engine and exhaust system is cool before proceeding. The oil filter is located on the left side of the engine.

10. Place some rags under the oil filter to contain spilled oil.
11. Turn oil filter counterclockwise to remove. Pull the oil filter to remove past the muffler.
12. Apply a film of clean engine oil to gasket of new filter.
13. Install filter. Turn filter clockwise until gasket makes contact with mounting surface. Tighten 1/2 to 3/4 turn after gasket contact.

IMPORTANT: Do not use wrench to tighten oil filter.

IMPORTANT: Refer to engine manufacturer's operating manual for correct type and grade of oil.

14. Add approximately 1.75 quarts of oil.
15. Insert dipstick. Replace oil filler cap.
16. Start engine and run at slow throttle for approximately two minutes. Check for leaks around oil filter and drain valve.
17. Stop engine.
18. Check oil level:
 - Remove dipstick. Wipe dipstick clean.
 - Insert dipstick fully and remove.
 - Add oil as needed to bring level to the FULL mark without overfilling.
19. Insert dipstick.

Cleaning Engine Oil Cooler and Checking Air Filter

Cleaning the Engine Oil Cooler

Keep engine oil cooler fins clear of debris to ensure proper cooling.

Refer to the engine manufacturer's owner's manual provided with your machine for the complete procedure.

Checking Air Filter Elements

IMPORTANT: Avoid damage! Dirt and debris can enter the engine through a damaged filter element:

- Do not wash paper element.
- Do not attempt to clean paper element by tapping against another object.
- Do not use pressurized air to clean element.
- Do not clean elements, only replace element if it is very dirty, damaged or the seal is cracked.

Your machine is equipped with a Heavy-Duty Air Cleaner assembly.

Check air filter elements at the intervals recommended in the **Service Intervals** section.

NOTE: It may be necessary to check the air filter more frequently if operating machine in dusty or extreme conditions.

Refer to the engine manufacturer's owner's manual provided with your machine for the complete procedure.

Replacing Fuel Filter

CAUTION

Avoid injury! Fuel vapors are explosive and flammable.

- Shut off engine before servicing.
- Cool engine before servicing.
- Work in a well-ventilated area.
- Do not smoke while handling fuel.
- Keep fuel away from flames or sparks.
- Clean up spilled fuel immediately.

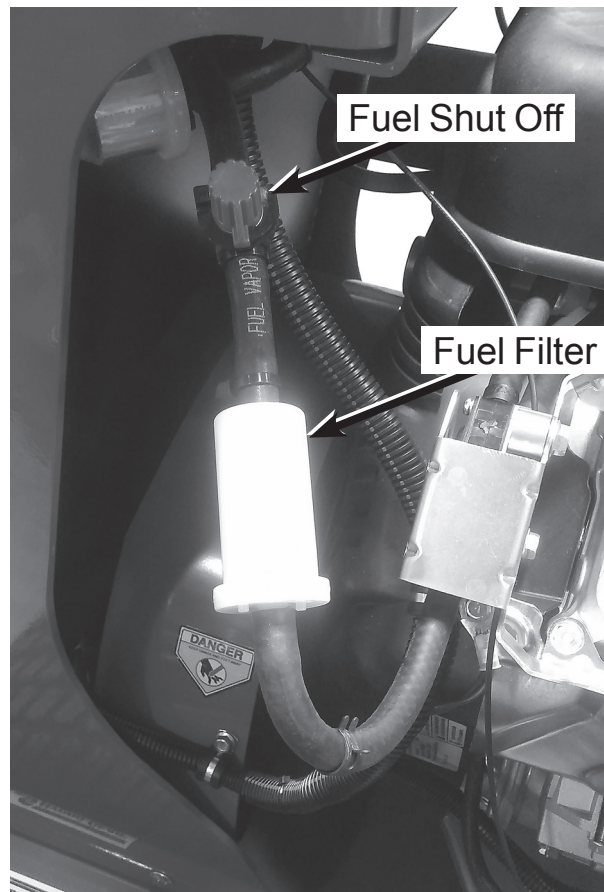

1. Park machine safely.
2. Allow engine to cool.
3. Turn OFF fuel shut off valve.
4. Loosen and slide hose clamps away from fuel filter.
5. Place drain pan under hoses to catch any fuel that may be left in the hoses.
6. Disconnect hoses from fuel filter.
7. Install new fuel filter by connecting hoses to new fuel filter. Make sure fuel filter is installed in the proper direction.
8. Install hose clamps.
9. Turn ON fuel shut off valve.
10. Start engine and check for fuel leaks.

Checking Engine Cooling Intake and Fan

IMPORTANT: Avoid damage! An obstructed air intake screen can cause engine damage due to overheating.

CAUTION

Avoid injury! Compressed air can cause debris to fly a long distance.

Clear work area of bystanders.

Wear eye protection when using compressed air for cleaning purposes.

Reduce compressed air pressure to 210 kPa (30 psi).

Keep air intake screen and other external surfaces of the engine, including cooling fins, clean at all times to allow adequate cooling.

Clean air intake screens and engine cooling fins of debris with compressed air to ensure proper cooling. Refer to the engine manufacturer's owner's manual provided with your machine for the complete procedure.

Checking Spark Plugs

CAUTION

Avoid injury! Touching hot surfaces can burn skin. The engine, components, and fluids will be hot if the engine has been running. Allow the engine to cool before servicing or working near the engine and components.

Check spark plugs at the intervals recommended in the **Service Intervals** section. Refer to the engine manufacturer's owner's manual provided with your machine for the complete procedure.

Checking Carburetor Adjustment

The carburetor is designed to deliver the correct fuel-to-air mixture to the engine under all operating conditions. To comply with current emissions regulations, the fuel mixture settings are made at the factory and are not adjustable.

NOTE: To ensure proper engine operation at altitudes above 5000 ft (1525M), it may be necessary to have an authorized engine service center install a special high-altitude jet kit in the carburetor.

Refer to the engine manufacturer's owner's manual provided with your machine for more information.

Service Hydraulics

Hydraulic Oil

Use only Mobil-1 synthetic 15W-50 oil or equivalent.

Checking Hydraulic Oil Level

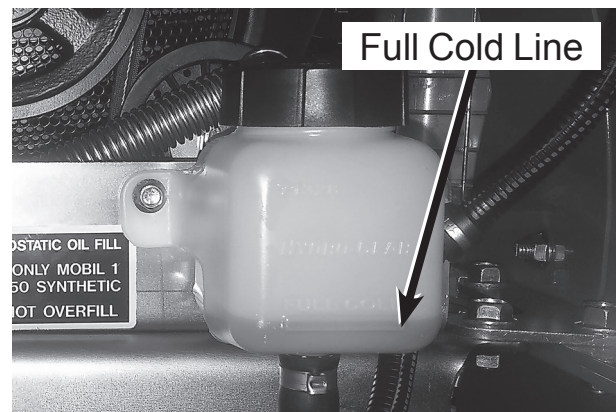

Hydraulic Oil Tank and Fill

CAUTION

Avoid injury! Escaping fluid under pressure can penetrate the skin causing serious injury. Avoid the hazard by relieving pressure before disconnecting hydraulic or other lines. Tighten all connections before applying pressure.

Search for leaks with a piece of cardboard. Protect hands and body from high pressure fluids.

IMPORTANT: Check oil level in reservoir tank when oil is cold.

Do not overfill oil reservoir tank. Oil will expand during operation and could overflow.

1. Park machine safely.
2. Allow engine to cool.
3. Clean reservoir and cap.
4. Sight through reservoir and ensure oil level is at the full cold line. If oil is low, add oil to bring oil level no higher than FULL COLD mark on tank.

NOTE: If oil is above FULL COLD line, drain oil to proper level.

5. Tighten cap.

Changing Hydraulic Oil and Filters

The transaxles are designed with an external filter for ease of maintenance. To ensure constant fluid quality levels and longer life, an initial oil and filter change at 75 hours, then every 400 hours thereafter.

The following procedure can be performed with the transaxles installed in the machine, and the machine on level ground.

1. Park machine safely. Engage the parking brake.
2. Allow engine and transaxles to cool.
3. Jack machine up from rear. Use blocking to support machine.
4. Remove both rear tires. Apply the bypass valves for both transaxles.

CAUTION: Skid plate is heavy.

5. Remove six 3/8-16 x 3/4 bolts that fasten skid plate in position.

Use a floor jack to support the skid plate. Lower jack and remove from under unit.

6. Remove toe kick to access the hydraulic filters, set aside.

Hydraulic Oil Filter (Not Visible Behind Filter Guard)

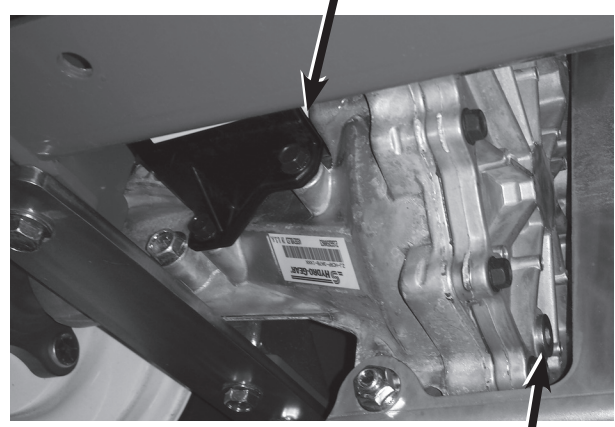

Drain Plug

Transaxle Drain Plug and Hydraulic Oil Filter.

7. Remove the three filter guard screws and filter guard. Clean any loose debris from around the perimeter of the filter. Place drain pan beneath the oil filter.
8. Remove the oil filter from the transaxle. Dispose of used filter properly.
9. Remove the drain plug from the transaxle, allow all fluid to drain.
10. After the oil has drained, wipe the filter base surface off and apply a film of new oil to the gasket of the new replacement filter.
11. Replace the drain plug.
12. Install the new filter by hand, turn 3/4 to one full turn after the filter gasket contacts the filter base surface. Do not use a wrench.
13. Re-install the filter guard with three screws. Torque screws to 65 in. lbs.
14. Repeat steps 8-14 on the opposite side transaxle drive.
15. Remove the purge port plug from the back of the transaxle. Refer to **Purge Port Plug Location** photo.

16. Remove the cap from the expansion tank, fill with Mobil 1 15W50 or equivalent motor oil until oil just appears at the bottom of each transaxle's purge port (approximately 2.5 qts. per transaxle, 5 qts. total). Install the purge port plug into each transaxle as the oil level reaches this port.

Purge Port Plug Located on the Top of the Pumps

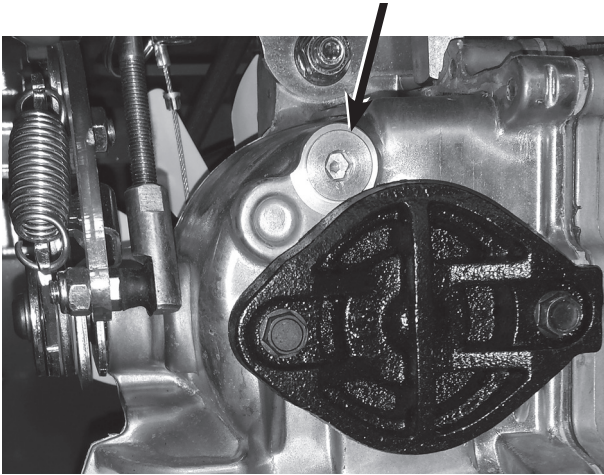

Purge Port Plug Location.

17. Torque the purge port plugs to 180 in. lbs.
 18. Continue to fill the transaxles through the expansion tank until the "Full Cold" line is reached.
 19. Re-install the expansion tank cap by hand. Be careful to not overtighten.
 20. Continue with the following purge procedure.
21. Engage neutral bypass valves.
 22. Start engine and idle up to 1800 rpm. Disengage parking brake.
 23. Slowly move the directional controls in both forward and reverse directions (5 or 6 times).
 24. Release bypass valves.
 25. Again, slowly move the directional controls in both forward and reverse directions (5 to 6 times).
 26. Stop engine. Engage parking brake. Check the oil level, and add oil as required.
 27. It may be necessary to repeat Steps 22 thru 26 until all the air is completely purged from the system.
 28. Re-install skid plate.
 29. Re-install rear tires and lower machine.
 30. Operate machine under normal conditions, when the transaxle operates at normal noise levels and moves smoothly forward and reverse at normal speeds, then the transaxle is considered purged. If necessary, repeat the purge procedure.

Purging Procedure

NOTE: Due to the effects air has on hydrostatic drive systems, it is critical that air is purged from the systems.

The resulting symptoms of air in the hydrostatic systems may be:

1. Noisy operation.
 2. Lack of power or drive after short term operation.
 3. High operation temperature and excessive expansion of oil.
- * (If starting here, Follow numbers 1-4 of the preceding page before continuing).

Impeller Removal and Inspection

Use this procedure to inspect or replace a broken impeller.

1. Park machine on a level surface. Remove key.
2. Allow machine to cool. Never perform work on a hot machine.
3. Take off the front safety cover by removing the six 5/16-18 x 3/4 front cover bolts.

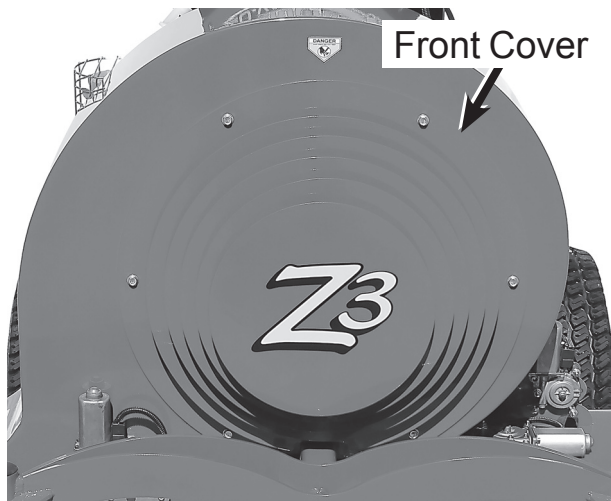

4. Remove the 7/16-20 x 1-1/2 impeller bolt.
5. Inspect impeller for cracks or damage. Replace the impeller if any damage is found. Contact your local dealer for original equipment manufacturer for replacement parts.
6. Replace 1/4 x 1/4 key if there is any damage to the key.
7. When re-installing the impeller bolt the threads must be clean of all oil, must use red Loctite and torque the impeller bolt to **80 ft-lbs.**
8. Replace safety cover in reverse order.

Caution should be used when removing impeller, it is heavy and there is not enough room for your fingers in the opening with the impeller, hold onto the impeller by the fins using gloves to remove from the housing.

Changing Drive Belt

1. Park machine on a level surface. Remove key.
2. Allow machine to cool. Never perform work on a hot machine.
3. Remove belt guard and two 5/16-18 flange nuts.



4. Use 3/4 wrench on idler pulley for leverage to loosen belt and remove belt from hydro pulley. Remove wrench.
5. Unthread the belt from the pulleys and discard.

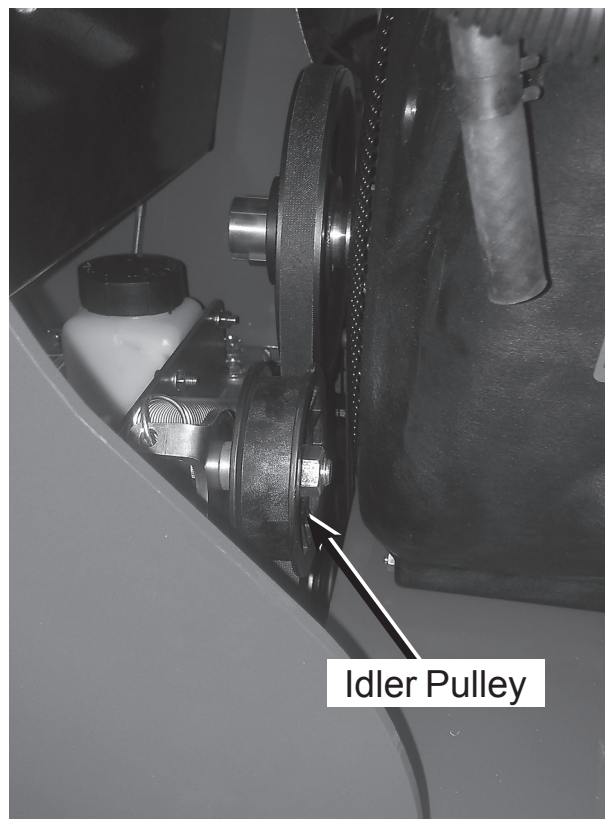
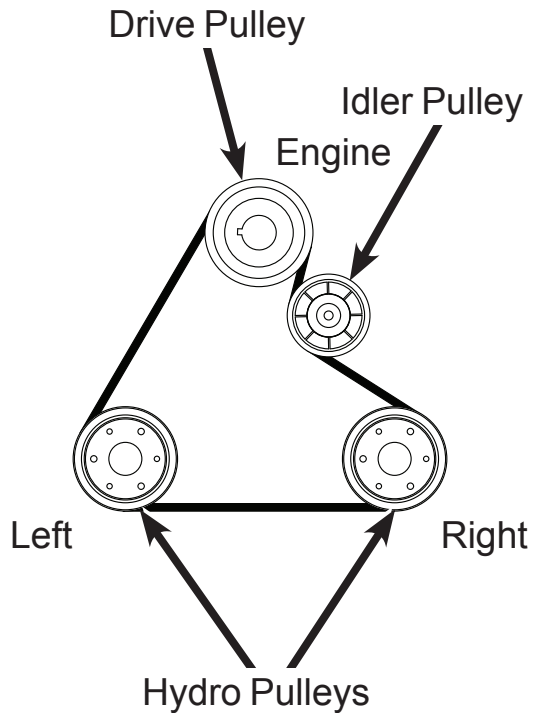

Figure 1

6. Thread the new belt over the pulleys in the correct routing (Refer to **Drive Belt Routing** diagram). Use 3/4 wrench to replace the tensions on the belt.
7. Replace belt guard, tighten nuts.



Drive Belt Routing Diagram
(View From the Back of the Unit)

8. At this time check the battery, if it needs replacing refer to *Removing and Installing Battery* procedure in the **Service** section.
9. Reassemble the unit by reversing the removal procedure.

Service Brakes

There is no serviceable brake adjustment, the brakes are automatic on this machine.

1. Emergency brake release, lift lever.



Service Motion Controls

Adjusting the Motion Controls

1. Park machine safely. Stop engine.
2. Chock wheels. Release parking brake.
3. Move both motion controls toward the handle bar full forward.
4. There should be exactly 1/16" between the motion controls and the handle bar. If the distance is greater or the controls touch the handle bar, adjustment is needed.

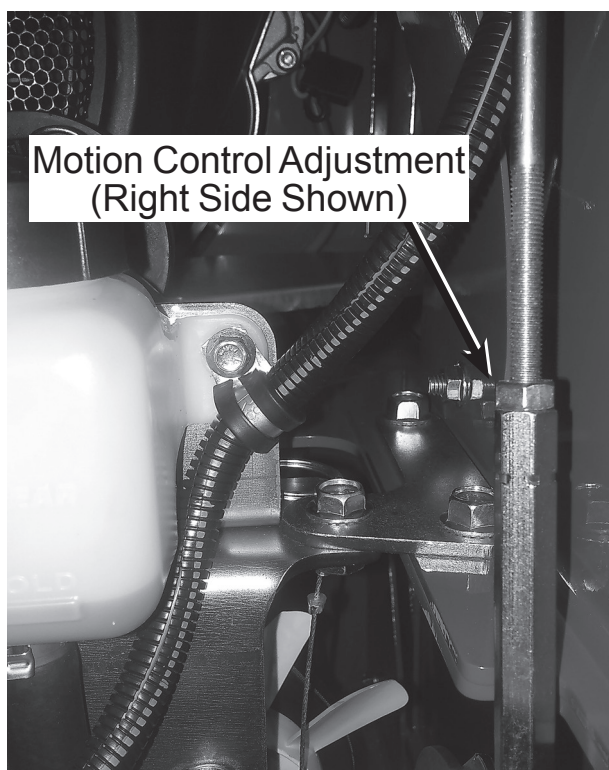

5. There are adjusters located by the transaxles on the back of the unit, just below the gas tank on the right and left sides. Loosen the jam nuts on the top and bottom of the adjuster.

NOTE: The top nuts are left hand thread and the bottom are right hand thread.

6. Holding the control forward to the handle bar, rotate the adjuster to get the 1/16" clearance to the handle bar and tighten the jam nuts. Repeat for both sides.

Adjusting Motion Controls - Checking Neutral Center

1. Choose a hard, level surface to perform this test.
2. Mount the machine. Start engine. Release the parking brake by tipping the handles down.
3. Ensure motion controls are in the NEUTRAL position.
4. If either drive wheel rotates while the motion control levers are in the NEUTRAL position, neutral adjustment is necessary.
5. Release handles allowing them to tip out to set the parking brake.

Adjusting Motion Controls Neutral Center

1. Park machine safely, block front casters.
2. Raise the rear of the machine, use jack stands or blocking under the chassis for safety. This procedure requires working on and running machine while on blocks, so make sure the machine is securely blocked.
3. Ensure motion controls are in the NEUTRAL position.

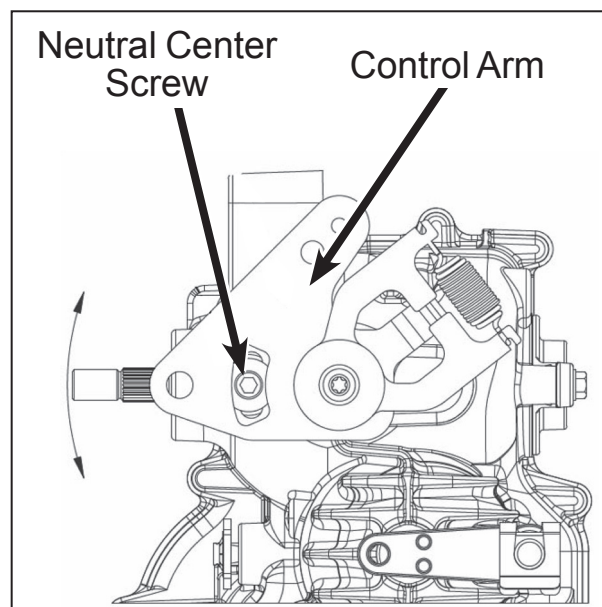

Left Side Transaxle Shown

4. Using a 1/4" allen wrench, Slightly loosen cap screw to allow the rotation of neutral return plate.

5. If left drive wheel rotates forward, rotate the neutral plate clockwise.
If left drive wheel rotates backward, rotate the neutral plate counterclockwise.
If right drive wheel rotates forward, rotate the neutral plate counterclockwise.
If right drive wheel rotates backward, rotate the neutral plate clockwise.
6. Only very small adjustments are necessary to set neutral center.
7. Tighten cap screw.
8. Check motion controls to ensure they return to the neutral position.
9. Mount the machine. Start engine. Idle engine.
10. Release parking brake.
11. Cycle motion controls forward and back. Return them to NEUTRAL position.
12. Observe both drive wheels for rotation. Stop engine. Engage parking brake. If either wheel rotates, repeat adjustment procedure until neutral is obtained.
13. If both wheels return to neutral and stop, lower machine.

Service Tires

Removing and Installing Rear Drive Wheels

Removing:

1. Park machine safely.
2. Lift machine with a safe lifting device centered under operator foot pad, placing blocking under the side where tire is being removed.
3. Remove the four wheel lug nuts.
4. Remove wheel.

Installing:

1. Install wheel with valve stem facing out.
2. Install and tighten wheel lug nuts until seated in the rim.
3. Torque rear wheel lug nuts to 75 lb-ft. in a cross pattern until value is reached.
4. Lower machine.

Removing and Installing Front Caster Wheels

Removing:

1. Park machine safely.
2. Lift front of machine with a safe lifting device. Use jackstands.
3. Loosen and remove locknut and axle bolt from caster fork.
4. Slide wheel out of fork.

Installing:

1. Slide replacement wheel into caster fork.
2. Install axle bolt and locknut.
3. Tighten locknut until wheel develops slight rolling resistance.
4. Lower machine.
5. Grease caster wheel.

Checking Tire Pressure



CAUTION

Avoid injury! Explosive separation of tire and rim is possible when serviced incorrectly: Do not attempt to mount a tire without the proper equipment and experience to perform the job. Do not inflate the tires above the recommended pressure. Do not weld or heat a tire and rim assembly. Heat can cause an increase in air pressure resulting in an explosion. Welding can structurally weaken or deform the rim. Do not stand in front or over the tire and rim when inflating.

Use a clip-on chuck and extension hose long enough to allow you to stand to one side.

1. Check tires for damage.
2. Check tire pressure with an accurate gauge.
3. Add or release air as necessary.

Recommended pressures:

Rear tire: **20 PSI - MAXIMUM 22 PSI**

Front tire: **20 PSI - MAXIMUM 28 PSI**

Service Electrical

Replacing Fuse

IMPORTANT

Avoid Damage! Help prevent machine electrical damage. Make sure replacement fuse is the correct rating.

1. Park machine safely.
2. Locate the fuse holder on the left side of the engine.

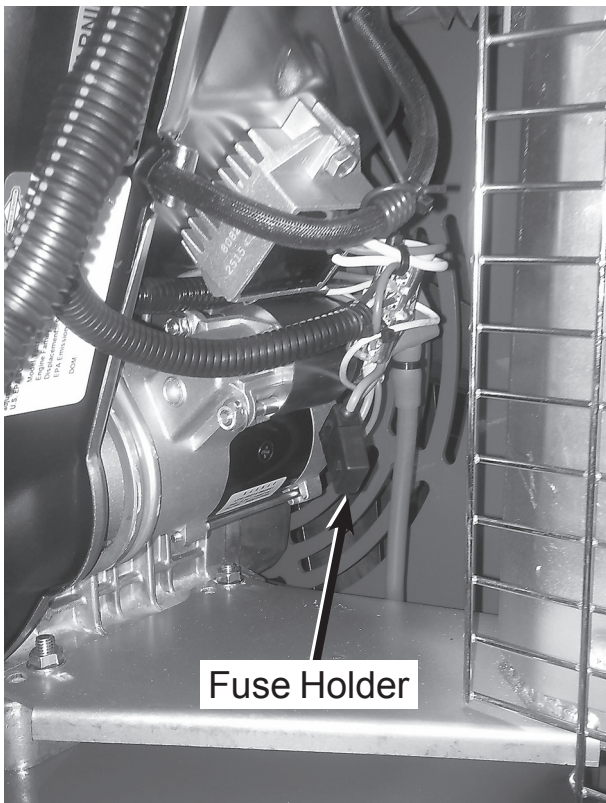

Fuse Holder

3. Open the fuse holder by pulling it apart carefully.
4. Remove the fuse and replace with the same type and rating. The fuse required is a 30 Amp Blade.
5. Carefully push cover back on.
6. Turn ON the lights to make sure that the fuse is properly installed.
7. Turn OFF lights.

Removing and Installing Battery

CAUTION

Avoid injury! Battery electrolyte contains sulfuric acid. It is poisonous and can cause serious burns.

- Wear eye protection and gloves.
- Keep skin protected.
- If electrolyte is swallowed, get medical attention immediately.
- If electrolyte is splashed into eyes, flush immediately with water for 15-30 minutes and get medical attention.
- If electrolyte is splashed onto skin, flush immediately with water and get medical attention if necessary.

WARNING

The battery produces a flammable and explosive gas. The battery may explode.

- Do not smoke near battery.
 - Do not allow direct metal contact across battery posts.
 - Disconnect negative cable first when removing battery.
 - Reconnect negative cable last when installing battery.
1. Park machine safely.
 2. You must remove the right side tire to remove the battery from the unit.
 3. Use a floor jack to lift the right side of the unit so the tire can be removed.
 4. Remove tire.
 5. Remove battery cover.

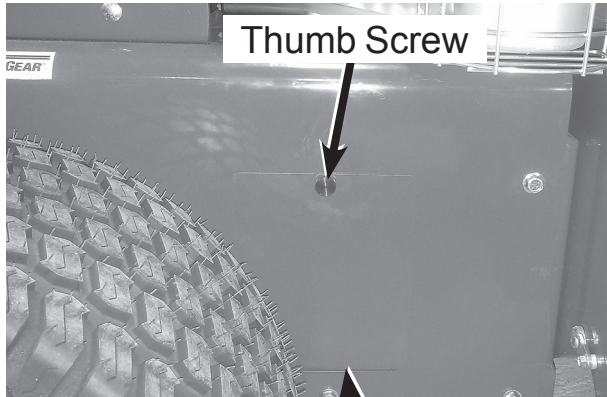

Remove Cover

6. Remove rubber strap holding battery in place.
7. Disconnect the Negative (-) battery cable first.
8. Disconnect the Positive (+) battery cable.
9. Remove battery from the tray.
10. Place positive cap back on new battery before installing.
11. Installing is reverse of above.

Cleaning Battery and Terminals

1. Park machine safely.
2. Disconnect and remove battery. Refer to *Removing and Installing Battery* procedure.
3. Clean battery with one gallon of water mixed with four tablespoons of baking soda. **Caution: DO NOT** get the soda solution into the cells.
4. Rinse the battery thoroughly with plain water and dry.
5. Clean terminals and battery cable ends with wire brush to remove corrosion. Replace the terminal bolts if corroded.
6. Apply battery terminal grease to the terminals and cable ends to prevent corrosion.
7. Install battery.

Using Booster Battery or Jump Starting

CAUTION

Avoid injury! The battery produces a flammable and explosive gas. The battery may explode.

- Do not smoke or have open flame near battery.
 - Wear eye protection and gloves.
 - Do not jump start or charge a frozen battery. Warm battery to 60°F before starting or charging.
1. Park machine safely.
 2. Remove battery box cover strap.
 3. Remove box cover.
 4. Connect the positive cable to the discharged battery first, and then to the good battery.
 5. Connect the negative jumper cable to the discharged battery first, and then to the good battery.
 6. Start engine of disabled machine.
 7. Disconnect the jumper cables from the good battery and then the discharged battery.

TROUBLESHOOTING

Using the Troubleshooting Chart

If you are experiencing a problem that is not listed in this chart, refer to the engine manufacturer's owner's manual provided with your machine for troubleshooting or contact your authorized service center.

When you have checked all the possible causes listed and you are still experiencing the problem, contact your authorized service center.

Engine	
Poor engine performance	Fuel: <ul style="list-style-type: none"> ● Dirt in fuel system or fuel is old. Replace fuel with fresh stabilized fuel. Obtain fuel from another supplier before suspecting machine problems. Suppliers blend fuels differently and changing suppliers will generally solve any performance problems. ● Fuel blended with alcohol or ether may contribute to performance problems by causing gum and varnish deposits, especially if fuel is stored for several weeks or more. Obtain fresh fuel. ● Replace fuel filter.
Engine will not start or is hard to start	<ul style="list-style-type: none"> ● Park brake lever not in the ENGAGED position. ● Check that motion control levers are in NEUTRAL. ● Stale, low fuel level or improper fuel. ● Plugged fuel filter. ● Plugged air intake filter. ● Spark plug wires loose or disconnected. ● Spark plugs not gapped correctly. ● Blown fuse. ● Electrical problem – dead battery. ● Choke applied incorrectly.
Engine will not slow idle	<ul style="list-style-type: none"> ● Carburetion problems. Contact your authorized service center. ● Bent or kinked throttle cable. ● Bent governor control. ● Incorrect governor idle control.
Engine runs rough or stalls	<ul style="list-style-type: none"> ● Plugged fuel filter. ● Plugged air intake system. ● Fuel cap vent dirty. ● Stale or improper fuel/fuel level. ● Spark plugs not gapped correctly. ● Replace spark plugs. ● Choke applied incorrectly.
Engine knocks	<ul style="list-style-type: none"> ● Engine oil level low. ● Fuel is bad. Fill tank with fresh fuel. ● Idle speed too slow. Increase engine rpms.

Engine overheats	<ul style="list-style-type: none"> ● Clean cooling fins. ● Clean engine cooling air intake screen. ● Low oil level. ● Do not operate at slow idle. Operate at faster idle. ● Plugged engine air intake filter.
Engine lacks power	<ul style="list-style-type: none"> ● Reduce load. ● Plugged engine air intake filter. ● Plugged fuel filter. ● Improper type of fuel. Drain tank and fill with correct fuel. ● Clean cooling fins to help prevent overheating. ● Replace spark plugs.
Engine backfires through muffler	<ul style="list-style-type: none"> ● Throttle lever should be at low idle for thirty seconds before turning off machine.
High fuel consumption	<ul style="list-style-type: none"> ● Improper type of fuel. ● Plugged air intake system. ● Improper valve clearance. Contact your authorized service center. ● Restricted air intake filter.
Other symptoms	<ul style="list-style-type: none"> ● Refer to engine manufacturer's owner's manual provided with your machine for additional information.
Electrical System	
Starter will not work	<ul style="list-style-type: none"> ● Blown fuse. ● Park brake not engaged or switch is faulty. ● Loose or corroded battery connections. ● Motion controls not in NEUTRAL or neutral safety switches faulty. ● Key switch, starter relay or starter faulty. Contact your authorized service center.
Battery will not charge	<ul style="list-style-type: none"> ● Loose or corroded connections. ● Defective battery. ● Defective rectifier. ● Contact your authorized service center.
Starter turns slowly	<ul style="list-style-type: none"> ● Loose or corroded battery connections. ● Defective battery. ● Low battery - charge battery. ● Engine oil viscosity too heavy.
Hydraulics	
Steering	<ul style="list-style-type: none"> ● Improper tire inflation. ● Pump free-wheel valve(s) partially open. ● Hydrostatic transmission oil level low. ● Pump drive belt loose or broken. ● Hydraulic pump or wheel motor faulty.

Machine will not move with engine running	<ul style="list-style-type: none"> ● Parking brake ENGAGED. ● Transmission oil level low. ● Transmission oil cold. Allow machine to warm up. ● Pump drive belt slipping or broken. ● Pump free-wheel valves open. ● Transmission problems. Contact your authorized service center.
Machine creeps with engine running and motion control levers in a NEUTRAL position	<ul style="list-style-type: none"> ● Needs motion control linkage neutral center adjustment.
Machine	
Excessive machine vibration	<ul style="list-style-type: none"> ● Engine speed too slow. Increase engine rpms. ● Drive belt not tensioned correctly. ● Impeller out of balance. Check impeller for damage, cracks, broken or bent fins. If damaged in any way, REPLACE IMPELLER.
Discharge deflectors not opening or closing	<ul style="list-style-type: none"> ● Deflector switch broken or sticking, replace switch. Contact your authorized service center. ● Deflector breaker bad, replace. Contact your authorized service center. ● Deflector motor damaged. Contact your authorized service center.

STORAGE

Storing Machine Safety



CAUTION

Avoid injury! Fuel vapors are explosive and flammable. Engine exhaust fumes contain carbon monoxide and can cause serious illness or death.

- Run the engine only long enough to move the machine to or from storage.
- **DO NOT** store vehicle with fuel in the tank inside a building where fumes may reach an open flame or spark.
- Allow the engine to cool before storing the machine in any enclosure.

Preparing Machine for Storage

1. Repair any worn or damaged parts. Replace parts if necessary. Tighten loose hardware.
2. Remove debris from machine.
3. Wash the machine and apply wax to metal and plastic surfaces.
4. Run machine for five minutes to dry belts and pulleys.
5. Apply light coat of engine oil to pivot and wear points to prevent rust.
6. Check tire pressure.

Preparing Fuel and Engine For Storage

Fuel:

If you have been using “Stabilized Fuel,” add stabilized fuel to tank until the tank is full. Turn OFF fuel shutoff.

NOTE: Filling the fuel tank reduces the amount of air in the fuel tank and helps reduce deterioration of fuel.

If you are not using “Stabilized Fuel”:

1. Park machine safely in a well-ventilated area.

NOTE: Try to anticipate the last time the machine will be used for the season so very little fuel is left in the fuel tank.

2. Turn ON engine and allow to run until it runs out of fuel.
3. Turn key to OFF position.
4. Mix fresh fuel and fuel stabilizer in separate container. Follow stabilizer instructions for mixing.
5. Fill fuel tank with stabilized fuel.
6. Run engine for a few minutes to allow fuel mixture to circulate through carburetor on engine.
7. Turn OFF engine. Turn OFF the fuel shutoff.

Engine storage:

1. Change engine oil and filter while engine is warm.
2. Service air filter if necessary.
3. Clean debris from engine air intake screen.
4. Remove spark plugs. Put 1 oz. of clean engine oil in cylinders. Install spark plugs, but do not connect spark plug wires. Crank the engine five or six times to allow oil to be distributed.
5. Clean the engine and engine compartment.
6. Remove battery.
7. Clean the battery and battery posts.
8. Close fuel shut-off valve.
9. Store the battery in a cool, dry place where it will not freeze.

NOTE: The stored battery should be recharged every 90 days.

10. Store the vehicle in a dry, protected place.

NOTE: Put a waterproof cover over on machine if stored outside.

Removing Machine From Storage

1. Check tire pressure.
2. Check engine oil level.
3. Check battery. Charge battery if necessary.
4. Install battery.
5. Check spark plug gap. Install and tighten plugs to specified torque.
6. Open fuel shut-off valve.
7. Run the engine 5 minutes at mid throttle with deflectors closed to allow oil to be distributed throughout engine.
8. Be sure to test all safety systems before operating.

HURRICANE
POWER